



Ruijie Reyee 5/8-Port Plastic Series Switches Hardware Installation and Reference Guide

Copyright Statement

Ruijie Networks©2021

Ruijie Networks reserves all copyrights of this document. Any reproduction, excerpt, backup, modification, transmission, translation or commercial use of this document or any portion of this document, in any form or by any means, without the prior written consent of Ruijie Networks is prohibited.

Exemption Statement

This document is provided "as is". The contents of this document are subject to change without any notice. Please obtain the latest information through the Ruijie Networks website. Ruijie Networks endeavors to ensure content accuracy and will not shoulder any responsibility for losses and damages caused due to content omissions, inaccuracies or errors.

Preface

Thank you for using our products. This manual will guide you through the installation of the device.

This manual describes the functional and physical features and provides the device installation steps, hardware troubleshooting, module technical specifications, and specifications and usage guidelines for cables and connectors.

Audience

It is intended for the users who have some experience in installing and maintaining network hardware. At the same time, it is assumed that the users are already familiar with the related terms and concepts.

Obtaining Technical Assistance

- Ruijie Networks Website: <https://www.ruijienetworks.com/>
- Technical Support Website: <https://ruijienetworks.com/support>
- Case Portal: <https://caseportal.ruijienetworks.com>
- Community: <https://community.ruijienetworks.com>
- Technical Support Email: service_rj@ruijienetworks.com
- Skype: [service_rj@ruijienetworks.com](https://www.skype.com/people/service_rj@ruijienetworks.com)

Related Documents

Documents	Description
Configuration Guide	Describes network protocols and related mechanisms that supported by the product, with configuration examples.
Command Reference	Describes the related configuration commands, including command modes, parameter descriptions, usage guides, and related examples.

Symbol Conventions

The symbols used in this document are described as below:

 Means reader take note. Notes contain helpful suggestions or references.

 This symbol means that you must be extremely careful not to do some things that may damage the device or cause data loss

1 Product Overview

The 5/8-port plastic series switches include the following models:

Model	10/100 Base-TX Auto-sensing Ethernet Port	10/100/1000 Base-T Auto-sensing Ethernet Port	1000Base-X SFP Port	Console Port
RG-ES05	5	N/A	N/A	N/A
RG-ES08	8	N/A	N/A	N/A
RG-ES05G	N/A	5	N/A	N/A
RG-ES08G	N/A	8	N/A	N/A

 1000Base-T is downward compatible with 100Base-TX and 10Base-T.

1.1 RG-ES05

Technical Specifications

Model	RG-ES05
Ports	Supports 5 10/100 Base-TX auto-sensing Ethernet ports.
Power Supply	<ul style="list-style-type: none"> ● AC input Rated voltage range: 100 VAC to 240 VAC Maximum voltage range: 90 VAC to 264 VAC Frequency: 50/60 Hz Rated current: 0.3 A ● Adapter output Rated voltage range: 5 VDC Rated current range: 0.6 A
EEE	Not supported
PoE	Not supported
Power Consumption	Less than 2.5W
Operating Temperature	0°C to 40°C (32°F to 104°F)
Storage Temperature	-40°C to 70°C (-40°F to 158°F)
Operating Humidity	10% to 90% RH
Storage Humidity	5% to 95% RH
Fan	Not supported
Temperature Warning	Not supported
Accessing Optical Module Information	Not supported

EMC Standards	GB9254-2008 EN 55032: 2015+A11:2020 EN 55035: 2017+A11: 2020 EN 61000-3-2: 2019 EN 61000-3-3: 2013+A1:2019 EN 300 386 V2.1.1(2016-07)
Security Standards	GB4943-2011 EN 62638-1
Earth Leakage Current	≤ 1.5mA
Dimensions (W x D x H)	108.1 mm x 64 mm x 24.8 mm (4.26 in. x 2.52 in. x 0.98 in.)
Weight (With Package)	0.19 kg (0.42 lbs)

! The RG-ES05 switch is a class A product. In a domestic environment, this product may cause radio interference in which case the user may be required to take adequate measures.

Product Appearance

On the front panel, the RG-ES05 Ethernet switch provides five 10/100Base-TX Ethernet ports and a DC power port.

Figure 1-1 Appearance of RG-ES05

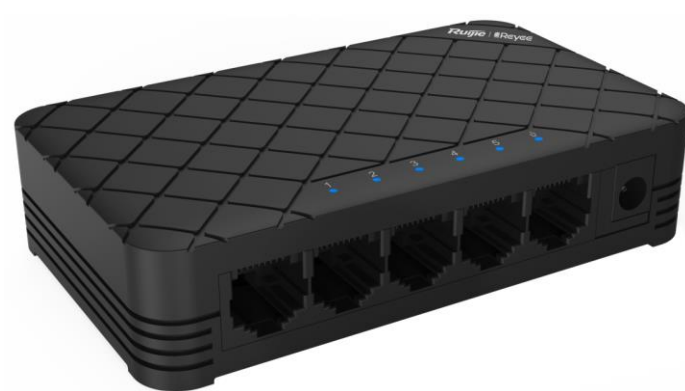

Front Panel

Figure 1-2 Front Panel of RG-ES05

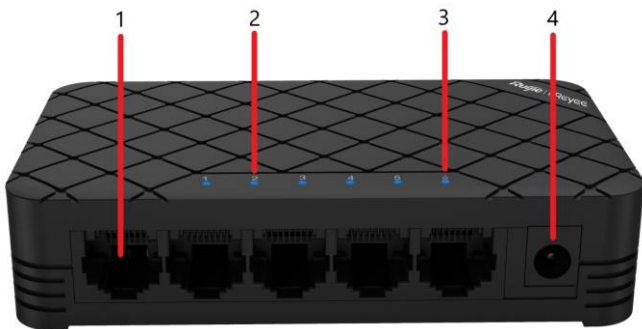

Note:	<ol style="list-style-type: none"> 1. 10/100Base-TX Ethernet port 2. RJ45 port status LED 3. System status LED 4. DC power port
-------	---

Heat Dissipation

The RG-ES05 adopts natural heat dissipation, thereby ensuring normal function of the device. Maintain a minimum clearance of 100 mm (3.94 in.) around the device. It is recommended to clean the device once every 3 months to avoid dust from blocking vents.

LEDs

LED	Panel Identification	State	Meaning
System status LED		Off	The switch is powered off.
		Solid on	The switch is operational.
RJ45 port status LED	1-5	Off	The port is not connected.
		Solid on	The port is connected at 10/100 Mbps.
		Blinking	The port is receiving or sending traffic at 10/100 Mbps.

1.2 RG-ES08

Technical Specifications

Model	RG-ES08
Ports	Supports 8 10/100 Base-TX auto-sensing Ethernet ports.
Power Supply	<ul style="list-style-type: none"> ● AC input <p>Rated voltage range: 100 VAC to 240 VAC Maximum voltage range: 90 VAC to 264 VAC Frequency: 50/60 Hz Rated current: 0.3 A</p> <ul style="list-style-type: none"> ● Adapter output <p>Rated voltage range: 5 VDC Rated current range: 0.6 A</p>

EEE	Not supported
PoE	Not supported
Power Consumption	Less than 3W
Operating Temperature	0°C to 40°C (32°F to 104°F)
Storage Temperature	-40°C to 70°C (-40°F to 158°F)
Operating Humidity	10% to 90% RH
Storage Humidity	5% to 95% RH
Fan	Not supported
Temperature Warning	Not supported
Accessing Optical Module Information	Not supported
EMC Standards	GB9254-2008 EN 55032: 2015+A11:2020 EN 55035: 2017+A11: 2020 EN 61000-3-2: 2019 EN 61000-3-3: 2013+A1:2019 EN 300 386 V2.1.1(2016-07)
Security Standards	GB4943-2011 EN 62638-1
Earth Leakage Current	≤ 1.5mA
Dimensions (W x D x H)	144 mm x 85 mm x 23 mm (5.67 in. x 3.35 in. x 0.91 in.)
Weight (With Package)	0.33 kg (0.73 lbs)

 The RG-ES08 switch is a class A product. In a domestic environment, this product may cause radio interference in which case the user may be required to take adequate measures.

Product Appearance

On the front panel, the RG-ES08 Ethernet switch provides eight 10/100Base-TX Ethernet ports and a DC power port.

Figure 1-3 Appearance of RG-ES08



Front Panel

Figure 1-4 Front Panel of RG-ES08

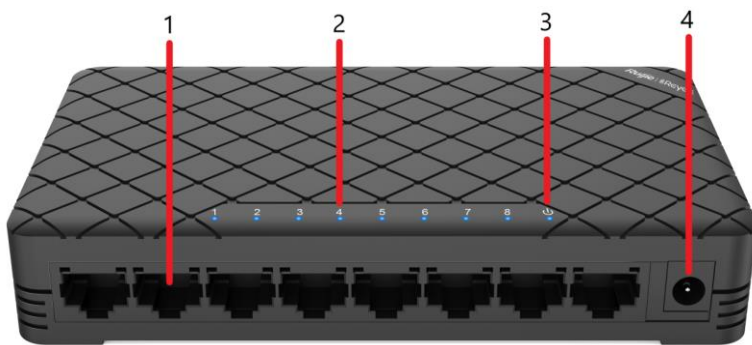

- Note:
1. 10/100Base-TX Ethernet port
 2. RJ45 port status LED
 3. System status LED
 4. DC power port

Heat Dissipation

The RG-ES08 adopts natural heat dissipation, thereby ensuring normal function of the device. Maintain a minimum clearance of 100 mm (3.94 in.) around the device. It is recommended to clean the device once every 3 months to avoid dust from blocking vents.

LEDs

LED	Panel Identification	State	Meaning
System status LED		Off	The switch is powered off.
		Solid on	The switch is operational.

RJ45 port status LED	1-8	Off	The port is not connected.
		Solid on	The port is connected at 10/100 Mbps.
		Blinking	The port is receiving or sending traffic at 10/100 Mbps.

1.3 RG-ES05G

Technical Specifications

Model	RG-ES05G
Ports	Supports 5 10/100/1000 Base-T auto-sensing Ethernet ports.
Power Supply	<ul style="list-style-type: none"> ● AC input Rated voltage range: 100 VAC to 240 VAC Maximum voltage range: 90 VAC to 264 VAC Frequency: 50/60 Hz Rated current: 0.3 A ● Adapter output Rated voltage range: 5 VDC Rated current range: 0.6 A
EEE	Not supported
PoE	Not supported
Power Consumption	Less than 3.5W
Operating Temperature	0°C to 40°C (32°F to 104°F)
Storage Temperature	-40°C to 70°C (-40°F to 158°F)
Operating Humidity	10% to 90% RH
Storage Humidity	5% to 95% RH
Fan	Not supported
Temperature Warning	Not supported
Accessing Optical Module Information	Not supported
EMC Standards	GB9254-2008 EN 55032: 2015+A11:2020 EN 55035: 2017+A11: 2020 EN 61000-3-2: 2019 EN 61000-3-3: 2013+A1:2019 EN 300 386 V2.1.1(2016-07)

Security Standards	GB4943-2011 EN 62638-1
Earth Leakage Current	$\leq 1.5\text{mA}$
Dimensions (W x D x H)	108.1 mm x 64 mm x 24.8 mm (4.26 in. x 2.52 in. x 0.98 in.)
Weight (With Package)	0.2 kg (0.44 lbs)

 The RG-ES05G switch is a class A product. In a domestic environment, this product may cause radio interference in which case the user may be required to take adequate measures.

Product Appearance

On the front panel, the RG-ES05G Ethernet switch provides five 10/100/1000Base-T Ethernet ports and a DC power port.

Figure 1-5 Appearance of RG-ES05G



Front Panel

Figure 1-6 Front Panel of RG-ES05G

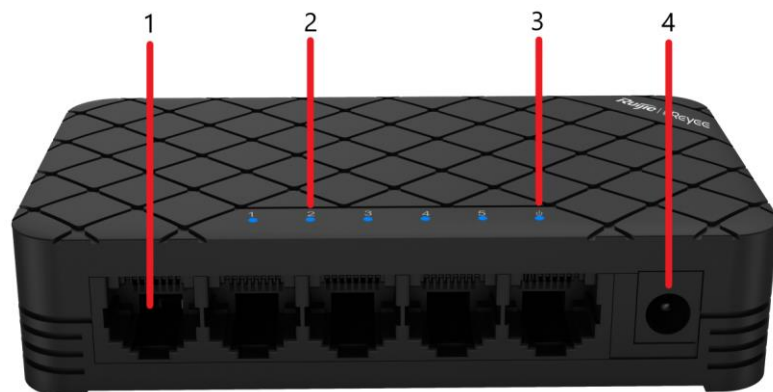

Note:	<ol style="list-style-type: none"> 1. 10/100/1000Base-T Ethernet port 2. RJ45 port status LED 3. System status LED 4. DC power port
-------	---

Heat Dissipation

The RG-ES05G adopts natural heat dissipation, thereby ensuring normal function of the device. Maintain a minimum clearance of 100 mm (3.94 in.) around the device. It is recommended to clean the device once every 3 months to avoid dust from blocking vents.

LEDs

LED	Panel Identification	State	Meaning
System status LED		Off	The switch is powered off.
		Solid on	The switch is operational.
RJ45 port status LED	1-5	Off	The port is not connected.
		Solid on	The port is connected at 10/100 Mbps.
		Blinking	The port is receiving or sending traffic at 10/100 Mbps.

1.4 RG-ES08G

Technical Specifications

Model	RG-ES08G
Ports	Supports 8 10/100/1000 Base-T auto-sensing Ethernet ports.
Power Supply	<ul style="list-style-type: none"> ● AC input <p>Rated voltage range: 100 VAC to 240 VAC Maximum voltage range: 90 VAC to 264 VAC Frequency: 50/60 Hz Rated current: 0.3 A</p> <ul style="list-style-type: none"> ● Adapter output <p>Rated voltage range: 9 VDC Rated current range: 0.6 A</p>

EEE	Not supported
PoE	Not supported
Power Consumption	Less than 6.5W
Operating Temperature	0°C to 40°C (32°F to 104°F)
Storage Temperature	-40°C to 70°C (-40°F to 158°F)
Operating Humidity	10% to 90% RH
Storage Humidity	5% to 95% RH
Fan	Not supported
Temperature Warning	Not supported
Accessing Optical Module Information	Not supported
EMC Standards	GB9254-2008 EN 55032: 2015+A11:2020 EN 55035: 2017+A11: 2020 EN 61000-3-2: 2019 EN 61000-3-3: 2013+A1:2019 EN 300 386 V2.1.1(2016-07)
Security Standards	GB4943-2011 EN 62638-1
Earth Leakage Current	≤ 1.5mA
Dimensions (W x D x H)	144 mm x 85 mm x 23 mm (5.67 in. x 3.35 in. x 0.91 in.)
Weight (With Package)	0.35 kg (0.77 lbs)

 The RG-ES08G switch is a class A product. In a domestic environment, this product may cause radio interference in which case the user may be required to take adequate measures.

Product Appearance

On the front panel, the RG-ES08G Ethernet switch provides eight 10/100/1000Base-T Ethernet ports and a DC power port.

Figure 1-8 Appearance of RG-ES08G



Front Panel

Figure 1-9 Front Panel of RG-ES08G

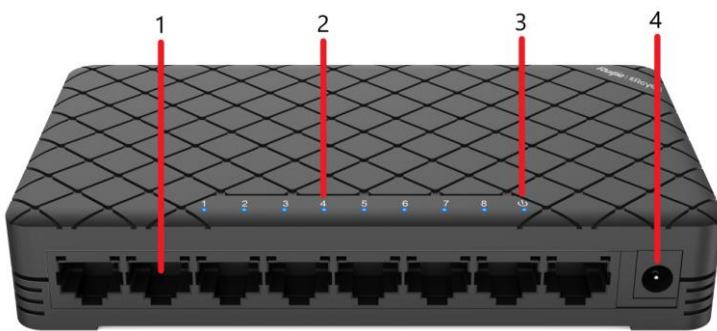

- Note:
1. 10/100/1000Base-T Ethernet port
 2. RJ45 port status LED
 3. System status LED
 4. DC power port

Heat Dissipation

The RG-ES08G adopts natural heat dissipation, thereby ensuring normal function of the device. Maintain a minimum clearance of 100 mm (3.94 in.) around the device. It is recommended to clean the device once every 3 months to avoid dust from blocking vents.

LEDs

LED	Panel Identification	State	Meaning
System status LED		Off	The switch is powered off.
		Solid on	The switch is operational.
RJ45 port status LED	1-8	Off	The port is not connected.

		Solid on	The port is connected at 10/100/1000 Mbps.
		Blinking	The port is receiving or sending traffic at 10/100/1000 Mbps.

2 Preparation before Installation

2.1 Safety Suggestions

 To avoid personal injury and equipment damage, please carefully read the safety suggestions before you install the 5/8-port plastic series switch.

 The following safety suggestions do not cover all possible dangers.

2.1.1 Installation

- Keep the chassis clean and free from any dust.
- Do not place the equipment in a walking area.
- Do not wear loose clothes or accessories that may be hooked or caught by the device during installation and maintenance.
- Turn off all power supplies and remove the power sockets and cables before installing or uninstalling the device.

2.1.2 Movement

- Do not frequently move the device.
- When moving the device, note the balance and avoid hurting legs and feet or straining the back.
- Before moving the device, turn off all power supplies and dismantle all power modules.

2.1.3 Electricity

- Observe local regulations and specifications when performing electric operations. Relevant operators must be qualified.
- Before installing the device, carefully check any potential danger in the surroundings, such as damp/wet ground or floor.
- Before installing the device, find out the location of the emergency power supply switch in the room. First cut off the power supply in the case of an accident.
- Try to avoid maintaining the switch that is powered-on alone.
- Be sure to make a careful check before you shut down the power supply.
- Do not place the equipment in a damp location. Do not let any liquid enter the chassis.

 Any nonstandard and inaccurate electric operation may cause an accident such as fire or electrical shock, thus causing severe even fatal damages to human bodies and equipment.

 Direct or indirect touch through a wet object on high-voltage and mains supply may bring a fatal danger.

 If a power supply system is equipped with a leakage protector (also referred to as "leakage current switch" or "leakage current breaker"), the rated leakage action current of each leakage protector is greater than twice of the theoretical maximum leakage current of all the power supplies in the system. For example, if a system is equipped with twenty identical power supplies, the leakage current of each power supply is equal to or less than 1.5mA, and the leakage

current of the system totals 30mA. A leakage protector with 30mA rated action current supports less than ten power supplies (that is, Action current of the leakage protector/2/Maximum leakage current of each power supply = $30/2/1.5=10$). In other words, the leakage protector with 30mA rated action current supports no more than ten power supplies. In this case, the twenty power supplies in the system require at least two leakage protectors with 30mA rated action current and each leakage protector supports ten power supplies. If power supplies in a system differ in models, the rated leakage action current of each leakage protector divided by two is greater than the sum of maximum leakage current of all the power supplies. The rated leakage non-action current of a leakage protector shall be 50% of the leakage action current. Take a leakage protector with 30mA rated leakage action current as an example. The rated leakage non-action current shall be 15mA. When the leakage current is below 15mA, the protector shall not act. Otherwise, misoperation may easily occur due to high sensitivity and thus the leakage protector trips, devices are powered off, and services are interrupted.

 To guarantee personal safety, the rated leakage action current of each leakage protector in the system must be equal to or less than 30mA (human body safety current is 30mA). When twice of the total leakage current of the system is greater than 30mA, the system must be equipped with two or more leakage protectors.

 For the leakage current value of each power supply model, see the power supply model parameter table in Chapter 1.

2.1.4 Static Discharge Damage Prevention

To prevent damage from static electricity, pay attention to the following:

- Indoor dust prevention.
- Proper humidity conditions.

2.2 Installation Site Requirements

To ensure the normal working and a prolonged durable life of the equipment, the installation site must meet the following requirements.

2.2.1 Ventilation

Maintain a minimum clearance of 100 mm (3.94 in.) around the device. After various cables have been connected, they should be arranged into bundles or placed on the cabling rack to avoid blocking the air inlets. It is recommended to clean the switch at regular intervals (like once every 3 months). Especially, avoid dust from blocking the screen mesh on the back of the cabinet.

2.2.2 Temperature and Humidity

To ensure the normal operation and prolong the service life of 5/8-port plastic series switch, you should keep proper temperature and humidity in the equipment room.

If the equipment room has temperature and humidity that do not meet the requirements for a long time, the equipment may be damaged.

- In an environment with high relative humidity, the insulating material may have bad insulation or even leak electricity. Sometimes the materials may suffer from mechanical performance change and metallic parts may get rusted.

- In an environment with low relative humidity, however, the insulating strip may dry and shrink. Static electricity may occur easily and endanger the circuit on the equipment.
- In an environment with high temperature, the equipment is subject to even greater harm, as its performance may degrade significantly and various hardware faults may occur.

Therefore, the ambient temperature and humidity of the 5/8-port plastic series switch must meet the requirements listed in Table 2-1.

Table 2-1 Temperature and Humidity Requirements of the 5/8-Port Plastic Series Switch

Temperature	Relative Humidity
0°C to 40°C (32°F to 104°F)	10% to 90%

 The requirements for the sampling site of the temperature and humidity in the operating environment of the device are as follows:

 The vertical height is 1.5 m above the floor.

 The distance from the front panel of the equipment is 0.4 m.

2.2.3 Cleanness

Dust poses a severe threat to the running of the equipment. The indoor dust falling on the equipment may be adhered by the static electricity, causing bad contact of the metallic joint. Such electrostatic adherence may occur more easily when the relative humidity is low, not only affecting the useful life of the equipment, but also causing communication faults. Table 2-2 shows the requirements for the dust content and granularity in the equipment room.

Table 2-2 Requirements for the Dust Content and Granularity in the Equipment Room

Dust	Unit	Density
Diameter \geq 0.5 μ m	Particles/m ³	$\leq 3.5 \times 10^6$
Diameter \geq 5 μ m	Particles/m ³	$\leq 3 \times 10^4$

Apart from dust, the salt, acid and sulfide in the air in the equipment room must also meet strict requirements, as such poisonous substances may accelerate the corrosion of the metal and the aging of some parts. The equipment room should be protected from the intrusion of harmful gases such as sulfur dioxide, sulfured hydrogen, nitrogen dioxide, and chlorine), whose requirements are listed in Table 2-3.

Table 2-3 Requirements for Harmful Gases in the Equipment Room

Gas	Average (mg/m ³)	Maximum (mg/m ³)
SO ₂	0.3	1.0
H ₂ S	0.1	0.5
NO ₂	0.5	1.0
Cl ₂	0.1	0.3

 Both average and maximum value are measured for a week. The switch cannot be placed in the environment with the maximum density for over 30 minutes every day. ...

2.2.4 EMI

Electro-Magnetic Interference (EMI), from either outside or inside the equipment or application system, affects the system in the conductive ways such as capacitive coupling, inductive coupling, and electromagnetic radiation.

There are two types of electromagnetic interference: radiated interference and conducted interference, depending on the type of the transmission path.

When the energy, often RF energy, from a component arrives at a sensitive component via the space, the energy is known as radiated interference. The interference source can be either a part of the interfered system or a completely electrically isolated unit. Conducted interference results from the electromagnetic wire or signal cable connection between the source and the sensitive component, along which cable the interference conducts from one unit to another. Conducted interference often affects the power supply of the equipment, but can be controlled by a filter. Radiated interference may affect any signal path in the equipment and is difficult to shield.

- Keep the equipment away from high-power radio transmitter, radar transmitting station, and high-frequency large-current device.
- Measures must be taken to shield static electricity.
- Interface cables should be laid inside the equipment room. Outdoor cabling is prohibited, avoiding damages to device signal interfaces caused by over-voltage or over-current of lightning.

2.3 Installation Tools

Table 2-4 Installation Tools

Common Tools	Phillips screwdriver, cables, bolts, diagonal pliers, straps
Special Tools	Anti-static wrist strap
Meters	Multimeter

 The tool kit is customer-supplied.

3 Product Installation

i Please ensure that you have carefully read Chapter 2.

3.1 Confirmations before Installation

Before installation, please confirm the following points:

- Whether ventilation requirements are met for the switch
- Whether the requirements of temperature and humidity are met for the switch
- Whether power cables are already laid out and whether the requirements of electrical current are met
- Whether related network adaption lines are already laid out

3.2 Installing the 5/8-Port Plastic Series Switches

Precautions

During installation, note the following points:

- Do not place any articles on the 5/8-port plastic series switch.
- Maintain a minimum clearance of 100 mm (3.94 in.) around the device. Do not stack the devices.
- The switch should be located at places free from the large power radio launch pad, radar launch pad, and high-frequency large-current devices. If necessary, electromagnetic shielding should be adopted. For example, use interface cables to shield cables.
- 100-meter network cables should be laid inside the equipment room and outdoor cabling of such cables is prohibited. If outdoor cabling is necessary, take relevant measures for lightning protection.

3.2.1 Mounting the Switch on the Wall

RG-ES05, RG-ES08, RG-ES05G and RG-ES08G can be mounted on the wall. (Mounting screws and wall anchors are customer supplied.)

In actual installation, users need to determine the size and depth of the two mounting holes on the wall based on the sizes of wall anchors and screws. Ensure that the wall anchors can be inserted into the holes, only the outer edges of the wall anchors are left outside the wall, and screws can be tightly fastened to the wall.

The following process takes RG-ES08/RG-ES08G as an example. The steps of mounting the switch on the wall are as follows:

Step 1: Drill two holes 104 mm (4.09 in.) far away from each other, and the line of connecting the two holes is horizontal.

Step 2: Insert wall anchors into the holes and ensure that the outer edges of the wall anchors are aligned with the wall.

Step 3: Put screws (ST4.2x20 recommended) into the wall anchors and ensure that the distance between the inner side of the screw head and the outer edge of the wall anchors not be smaller than 2.5 mm (0.10 in.) so that the device can be securely mounted on the screws.

Step 4: As shown in Figure 3-1, Align the two mounting holes on the bottom of the chassis of the device with the screws, and then fasten the device on the screws.

Figure 3-1 Mounting the Switch on the Wall

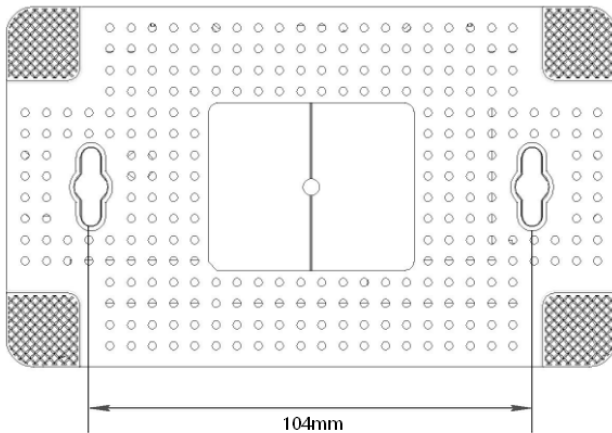

 Suitable for mounting on concrete or other non-combustible surface only.

3.2.2 Mounting the Switch on a Table

The following process takes RG-ES08/RG-ES08G as an example. Place the switch on a table, as shown in Figure 3-2.

Figure 3-2 Placing the Switch on a Table

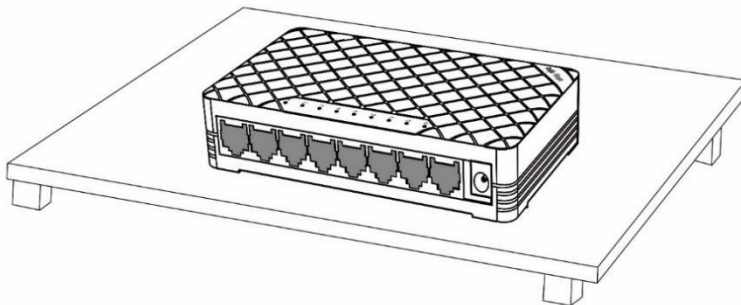

 The device must be installed and operated in the place that can restrict its movement.

3.3 Checking after Installation

 Before checking the installation, switch off the power supply so as to avoid any personal injury or damage to the component due to connection errors.

- Check that the cables and power input cables are correctly connected.
- Check that all interface cables are laid out inside the equipment room. In the case of external cabling, check that the lightning resistance socket or network interface lightning protector is connected.
- Maintain a minimum clearance of 100 mm (3.94 in.) around the device.

3.4 Adding Unmanaged Device to Topology

Note: There must be devices that can be managed in the network, including Ruijie EG or ES2/NBS switches.

Scenarios:

- Add a new unmanaged switch: Select its uplink device, and scan the QR-code on the switch or manually add it to the topology.
- If the unmanaged switch is already added to the topology and displayed as a virtual device: Select the virtual device, and scan its QR-code or manually enter its information to the topology.

3.4.1 Scanning QR-code of Unmanaged Device

1. Tap **Topology** to open the topology page.

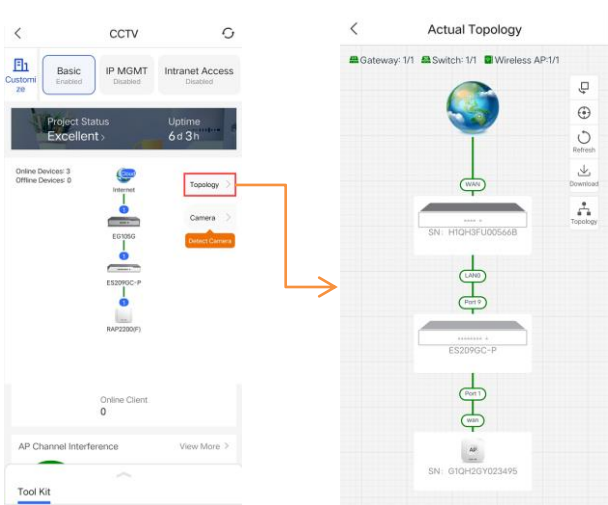

2. Tap the **Topology** button, and select the existing managed device. To add an unmanaged downlink switch by scanning its QR-code, select **Scan to Add**.

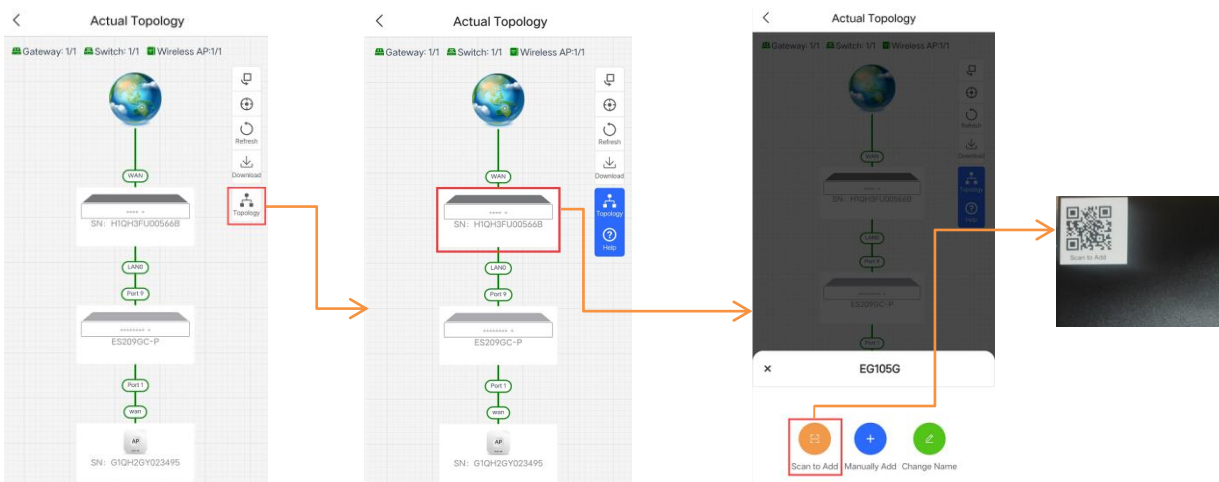

3. After the device is detected, select its uplink port. And the device is added successfully.

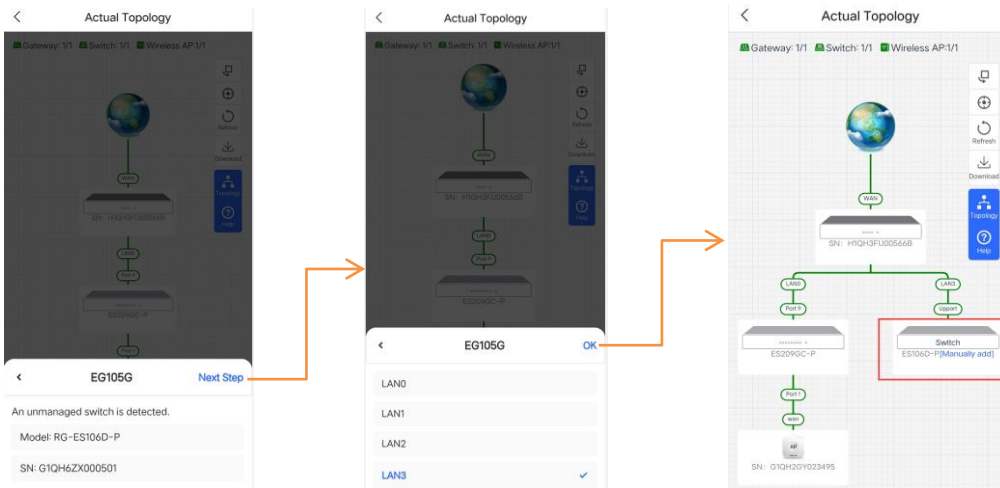

3.4.2 Adding Unmanaged Device Manually

1. Tap **Topology** to enter the topology page.

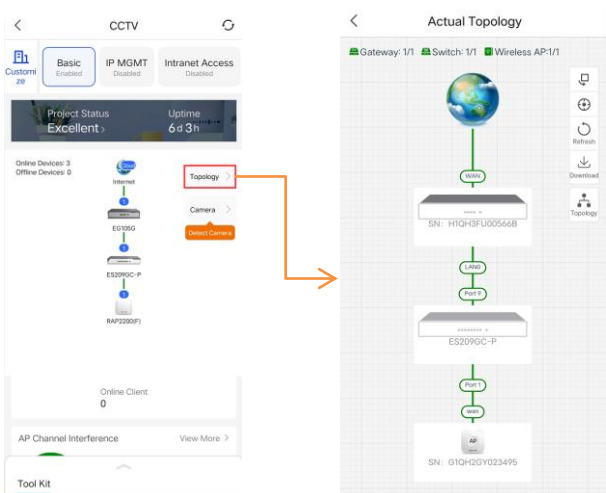

2. Tap the **Topology** button, and select the existing managed device. To add an unmanaged downlink switch manually, select **Manually Add**.

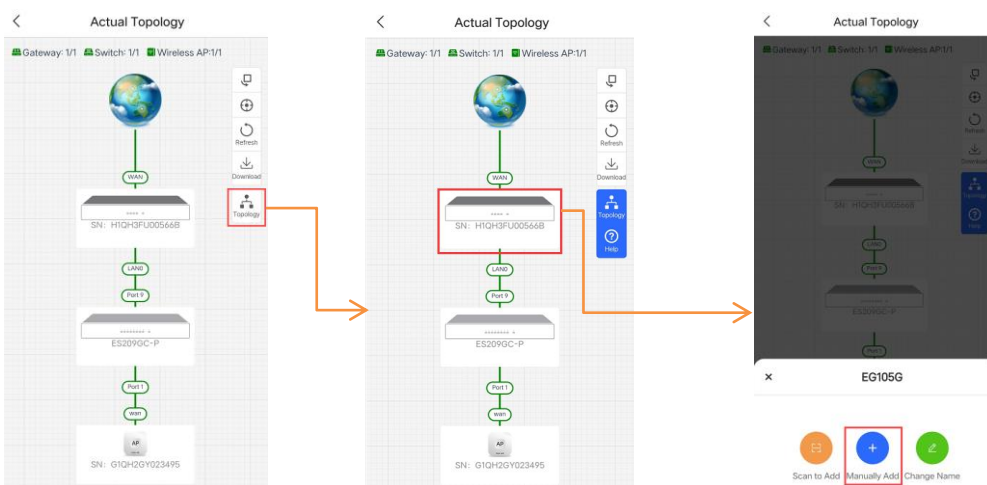

3. Select the device model and its uplink port, and the device is added successfully.

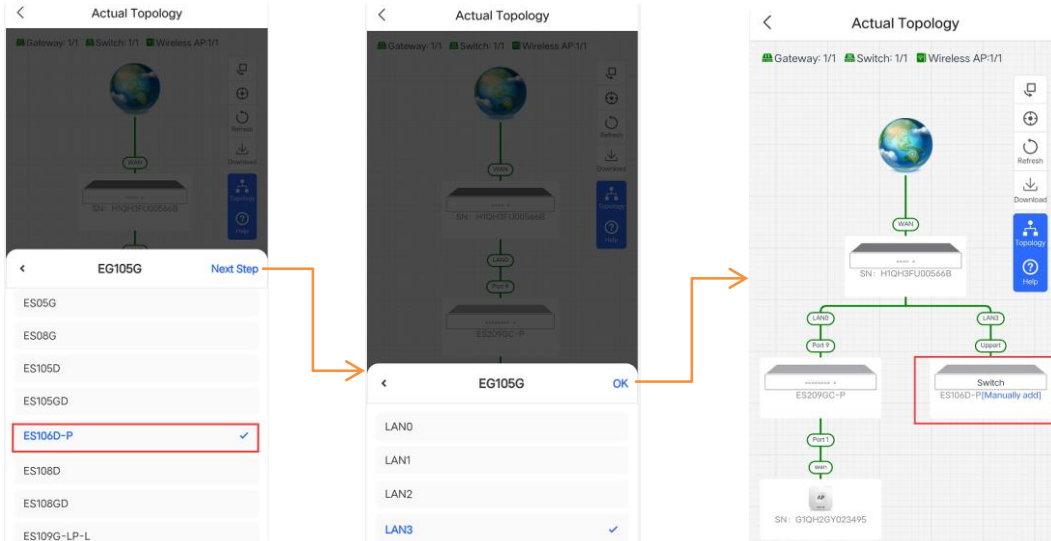

4 System Debugging

4.1 Startup Check

4.1.1 Checking before the Device is Powered on

- The power cable is correctly connected.
- The power supply voltage complies with the requirement of the switch.

4.1.2 Checking after Program Startup (Recommended)

After power-on, you are recommended to perform the following checks to ensure the normal operation of follow-up configurations.

- Check whether the status of the switch indicator is normal.
- Check whether the service interface forwards data normally.

5 Maintenance and Troubleshooting

5.1 General Troubleshooting Procedure

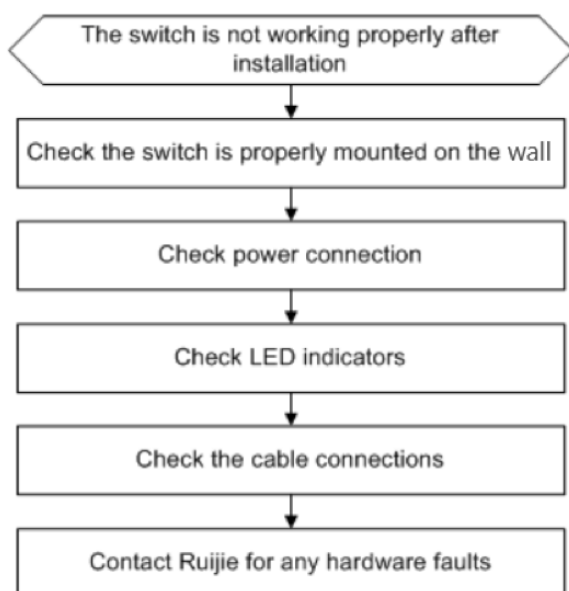

5.2 Troubleshooting Common Faults

Symptom	Possible Causes	Solution
The status indicator is not on after the switch is started.	The power module does not work. The power cable is in loose contact.	Check whether the power socket at the equipment room is normal and whether the power cable is plugged in.
The RJ45 port is not in connectivity or it is erroneous in receiving/transmitting frames.	The connected twisted pair cable is faulty. The length of the cable exceeds 100 m. The port has special configuration that has no common working mode with the connected switch.	Replace the twisted pair cable. Check that the port configuration has the common working mode with the connected switch.

Appendix A Connectors and Connection Media

1000BASE-T/100BASE-TX/10BASE-T Ports

The 1000BASE-T/100BASE-TX/10BASE-T is a port that supports adaptation of three rates, and automatic MDI/MDIX Crossover at these three rates.

The 1000BASE-T complies with IEEE 802.3ab, and uses the cable of 100-ohm Category-5 or Supper Category-5 UTP or STP, which can be up to 100 m.

The 1000BASE-T port uses four pairs of wires for transmission, all of which must be connected. Figure A-1 shows the connections of the twisted pairs used by the 1000BASE-T port.

Figure A-1 Four Twisted Pairs of the 1000BASE-T

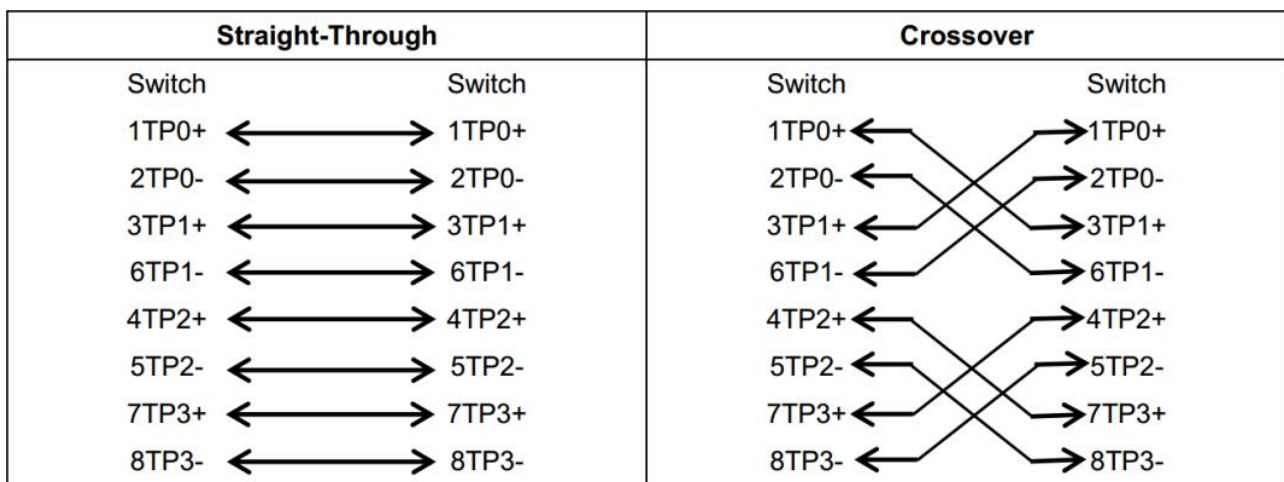

In addition to the above cables, the 100BASE-TX/10BASE-T can also use 100-ohm Category-3, 4, 5 cables for 10 Mbps, and 100-ohm Category-5 cables for 100 Mbps, both of which can be up to 100 m. Figure A-2 shows the pinouts of the 100BASE-TX/10BASE-T.

Figure A-2 Pinouts of the 100BASE-TX/10BASE-T

Pin	Socket	Plug
1	Input Receive Data+	Output Transmit Data+
2	Input Receive Data-	Output Transmit Data-
3	Output Transmit Data+	Input Receive Data+
6	Output Transmit Data-	Input Receive Data-
4,5,7,8	Not used	Not used

Figure A-3 shows the straight-through and crossover cable connections for the 100BASE-TX/10BASE-T.

Figure A-3 Connections of the Twisted Pairs of the 100BASE-TX/10BASE-T

Straight-Through		Crossover	
Switch	Adapter	Switch	Switch
1 IRD+	1 OTD+	1 IRD+	1 OTD+
2 IRD-	2 OTD-	2 IRD-	2 OTD-
3 OTD+	3 IRD+	3 OTD+	3 IRD+
6 OTD-	6 IRD-	6 OTD-	6 IRD+

Optical Fiber Connection

For the optical fiber ports, select single-mode or multiple-mode optical fibers for connection according to the fiber module connected. The connection schematic diagram is shown in Figure A-4:

Figure A-4 Optical Fiber Connections

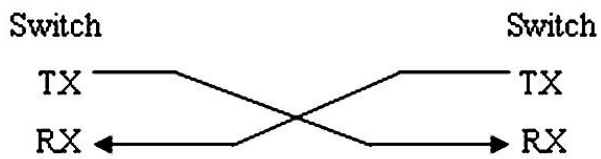

Appendix B Lightning Protection

Installing AC Power Arrester (lightning protection cable row)

The external lightning protection cable row shall be used on the AC power port to prevent the switch from being struck by lightning when the AC power cable is introduced from the outdoor and directly connected to the power port of the switch. The lightning protection cable row is fixed on the cabinet, operating table or the wall in the machine room using the line buttons and screws.

Figure B-1 Schematic Diagram for the Power Arrester

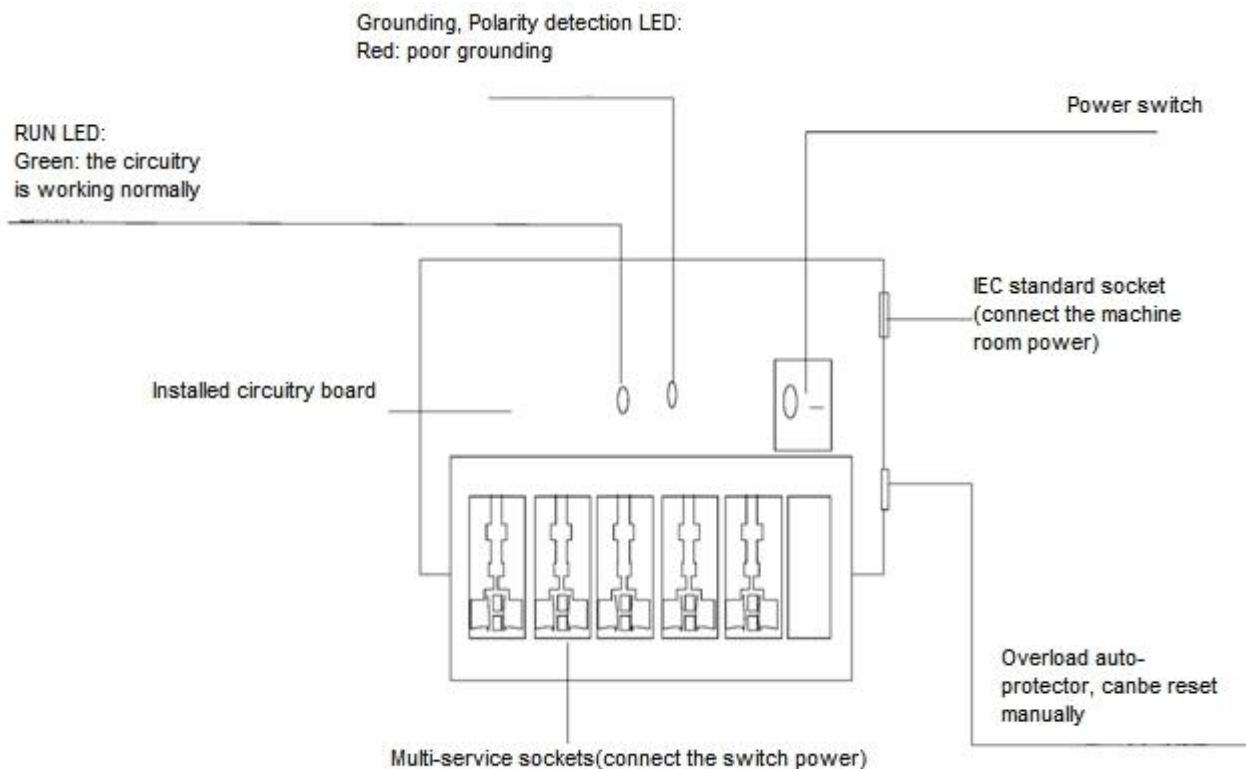

! The power arrester is not provided and the user shall purchase it to address the practical requirement.

Precautions for installation:

- Make sure that the PE terminal of the power arrester has been well-grounded;
- After connecting the switch AC power plug to the socket of the power arrester (lightning protection cable row), lightning protection function implements if the RUN LED is Green and the ALARM LED is OFF.
- If the ALARM LED on the power arrester is Red, you shall check what the reason is, poor grounding connection or the reversed connection of the Null and Live lines: Use the multimeter to check the polarity of the power socket for the arrester when the LED is Red, if the N line is on the left and the L line is on the right, the arrester PE terminal is not grounded; if the L line is on the left and the N line is on the right, the polarity of the arrester power cable shall be reversed; if the LED is still Red, it is confirmed that the arrester PE terminal has not been grounded.

Installing the Ethernet Port Arrester

During the switch usage, the Ethernet port arrester shall be connected to the switch to prevent the switch damage by lightning before the outdoor network cable connects to the switch.

Tools: Cross or straight screwdriver, Multimeter, Diagonal pliers

Installation Steps:

1. Tear one side of the protection paper for the double-sided adhesive tape and paste the tape to the framework of the Ethernet port arrester. Tear the other side of the protection paper for the double-sided adhesive tape and paste the Ethernet port arrester to the switch framework. The paste location for the Ethernet port arrester shall be as close to the grounding terminal of the switch.
2. Based on the distance of the switch grounding terminal, cut the grounding line for the Ethernet port arrester and firmly tighten the grounding line to the grounding terminal of the switch.
3. Use the multimeter to check whether the grounding line for the arrester is in good contact with the switch grounding terminal and the framework.
4. According to the description on the Ethernet Port Arrester Hardware Installation Guide, connect the arrester using the adapter cable (note that the external network cable is connected to the end of IN, while the adapter cable connected to the switch is connected to the end of OUT) and observe whether the LED on the board is normal or not.
5. Use the nylon button to bundle the power cables.

Figure B-2 Schematic Diagram for the Ethernet port Arrester Installation

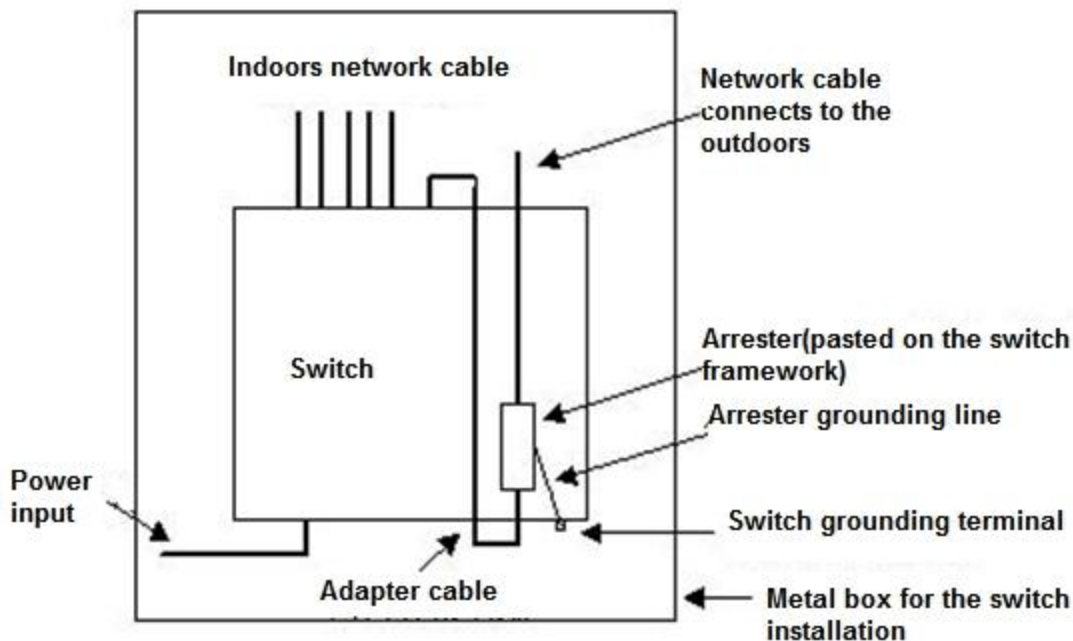

- ⚠ The Ethernet port arrester is only for the 10M/100M copper Ethernet ports with the RJ45 connector;
- ⚠ The Ethernet port arrester is not provided, the user can purchase them to address their own practical requirements. For the detailed information during the arrester installation, please refer to Ethernet Port Arrester Hardware Installation Guide, which contains the technical specification and the maintenance and installation of the arrester.

You may pay attention to the following conditions during the actual installation to avoid influencing the performance of the Ethernet port arrester:

- Reversed direction of the arrester installation. You shall connect the external network cable to the “IN” end and connect the switch Ethernet port to the “OUT” end.
- Poor arrester grounding. The length of the grounding line should be as short as possible to ensure that it is in good contact with the switch grounding terminal. Use the multimeter to confirm the contact condition after the grounding.
- Incomplete arrester installation. If there is more than one port connected to the peer device on the switch, it needs to install the arresters on all connection ports for the purpose of the lightning protection.